

Introducing Waterguard, Australia's only antimicrobial poly rainwater tank!

Creating fresher, cleaner water for you and your family



Reduces Odours



Reduces Bacteria



Antimicrobial Water Tank

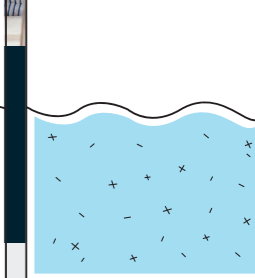

Regular Untreated Water Tank

\* For illustrative purposes only



6 Star Energy Rating



Safely Treated with Antimicrobial Technology



Better for the Environment



Australian Made



BPA FREE

Partnering with global leaders SANITIZED AG, our new Waterguard rainwater tanks are infused with Sanitized® antimicrobial protection. Organic matter such as algae, mould

and mildew can build-up inside your tank, which can make it dirty, and can contaminate your rainwater. Our antimicrobial treatment actively protects against this, keeping your family safe

from harmful bacteria and extending the life of your tank.

Visit [www.polymaster.com.au/waterguard](http://www.polymaster.com.au/waterguard) for details

# Small Tanks

- Waterguard Tanks NEW
- Small Round Tanks 200-7,000ltr
- Slimline Tanks
- Tank & Pump Packages
- Tank Accessories

## WATERGUARD IS AVAILABLE ON THE FOLLOWING TANK RANGES



### SLIMLINE RAINWATER TANKS

→ 2000L – 3000 litres  
→ See pg.14-15 for tank information



### 2020L TANK & PUMP PACKAGE

→ See pg.16-17 for tank information



### ROUND RAINWATER TANKS

→ 200 - 9000 litres  
→ See pg.6-7 & pg.12-13 for tank information

## COLOUR RANGE

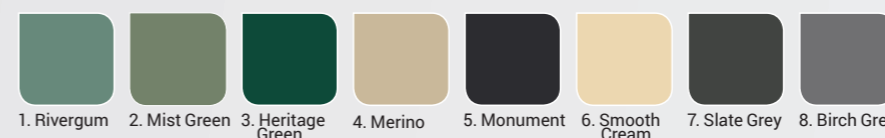

1. Rivergum 2. Mist Green 3. Heritage Green 4. Merino 5. Monument 6. Smooth Cream 7. Slate Grey 8. Birch Grey



“ We are very pleased with the choice we made to go with Polymaster due to the quality and excellent service. We will endeavour to use more Polymaster tanks as we continue to upgrade our property.  
- Matthew, Bridgewater SA

” 02

# Small Round Tanks 200-7,000ltr

**ALL TANKS ARE CERTIFIED TO THE RAINWATER TANK STANDARD AS/NZS4766:2006**



## CERTIFIED

- Self-supporting roof design means no support poles are necessary
- Extra thick walls for maximum strength
- One-piece construction means there are no joins, seams or part-lines
- Specially formulated double strength UV+ resin on the complete colour range ensures ultimate protection against Australia's harsh sun
- RWT range available in 22 Colorbond® colours
- PCR range available in 12 Standard Colorbond® colours - Other colours available on request at 5% surcharge

Pages 5-9  
**LARGE TANKS**

Page 11  
**WATERGUARD TANKS**

Pages 18-19  
**COLOUR RANGE**

Pages 82-83  
**DELIVERY & INSTALLATION**

**ONLINE WATER CALCULATOR**

Calculator icon

CALCULATOR.  
POLYMASTER.COM.AU

**WHY CHOOSE POLYMASTER?**  
SEE PG.4



## RWT - RAINWATER TANKS (CORRUGATED & SMOOTH WALL)

CODE	LITRES	DIAMETER	INLET HEIGHT	OVERALL HEIGHT	STRAINER (POSITION, SIZE)	OVERFLOW (ALTERNATIVE)	OUTLET (Std) (POSITION, SIZE)
RWT200	200 (45gal)	600 mm (2')	900 mm (2'11")	900 mm (2'11")	Centre, 200 mm	12	6, 25 mm
RWT600	600 (110gal)	1000 mm (3'3")	950 mm (3'1")	950 mm (3'1")	Centre, 200 mm	12	6, 25 mm
RWT1000	1000 (220gal)	1000 mm (3'3")	1500 mm (4'11")	1500 mm (4'11")	Centre, 200 mm	12	6, 25 mm
RWT1600	1600 (350gal)	1250 mm (4'1")	1500 mm (4'11")	1610 mm (5'3")	12, 300 mm	11 / 4	6, 25 mm
RWT2270T	2270 Tall (500gal)	1300 mm (4'3")	1920 mm (6'4")	2000 mm (6'6")	12, 300 mm	11 / 5	6, 25 mm
RWT2270LP	2270 Low Profile (500gal)	1700 mm (5'8")	1200 mm (4')	1310 mm (4'3")	12, 400 mm	11 / 4	6, 25 mm
RWT3300	3300 (730gal)	1520 mm (5')	2000 mm (6'6")	2100 mm (6'10")	12, 300 mm	11 / 4	6, 25 mm
RWT4500T	4500 Tall (1000gal)	1700 mm (5'8")	2100 mm (6'11")	2200 mm (7'3")	12, 400 mm	11 / 4	6, 25 mm
RWT4500LP	4500 Low Profile (1000gal)	2150 mm (7'2")	1380 mm (4'6")	1580 mm (5'2")	12, 400 mm	11 / 3 / 7	6, 25 mm
RWT5000	5000 (1100gal)	1950 mm (6'5")	1960 mm (6'5")	2170 mm (7'2")	12, 400 mm	11 / 3 / 7	6, 25 mm
RWT7100	7100 (1500gal)	2150 mm (7'2")	2120 mm (7')	2300 mm (7'5")	12, 400 mm	11 / 3 / 7	6, 40 mm

## AVAILABLE IN WATERGUARD - New technology to keep your water fresher for longer.

CODES: WGRWT200 / WGRWT600 / WGRWT1000 / WGRWT1600 / WGRWT2270T / WGRWT2270LP / WGRWT3300 / WGRWT4500T / WGRWT4500LP / WGRWT5000 / WGRWT7100



\* Refer to the RWT codes above for tank dimensions

- See pg.11 for Waterguard info.

## PCR - RAINWATER TANKS (SMOOTH WALL)

CODE	LITRES	DIAMETER	INLET HEIGHT	OVERALL HEIGHT	STRAINER (POSITION, SIZE)	OVERFLOW (ALTERNATIVE)	OUTLET (Std) (POSITION, SIZE)
PCR2000	2000 (440gal)	1175 mm (3'11")	2185 mm (7'2")	2255 mm (7'4")	12, 300 mm	10.30/1.30/4.30/7.30	6, 25 mm
PCR4000	4000 (880gal)	1600 mm (5'2")	2150 mm (7'1")	2200 mm (7'2")	12, 400 mm	10.30/1.30/4.30/7.30	6, 25 mm
PCR5000	5000 (1100gal)	1800 mm (5'11")	2120 mm (7')	2200 mm (7'2")	12, 400 mm	10.30/1.30/4.30/7.30	6, 25 mm
PCR7000	7000 (1500gal)	2200 mm (7'2")	2020 mm (6'6")	2200 mm (7'2")	12, 400 mm	10.30/1.30/4.30/7.30	6, 25 mm

## TANK ROOF DIAGRAM FOR FITTING POSITIONS

Please see table and diagram to choose your preferred overflow and outlet positions.

Brass outlets can be placed anywhere on flat skirt of tank.

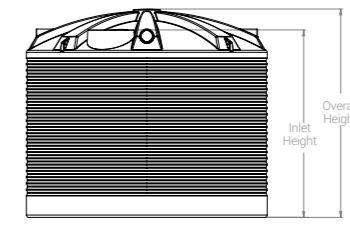

## FIT-OUT CLOCK

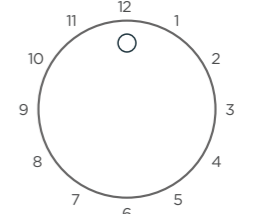

\* Refer to table for strainer, overflow & outlet positions available for each tank size

## ROUND TANK STANDARD FITTINGS

**1**

Mosquito proof leaf screen

**2**

Moulded lugs for easy lifting and tie-down points

**3**

90 mm Overflow fitting

Solid Brass Threaded Outlet & 25mm Ball Valve [RWT Range]

OR

Solid Brass Threaded Outlet [PCR Range]

\* Additional sizes available

All measurements are approximate due to variable shrinkage during manufacture. Due to pigment variations with raw material manufacturers, colour shades may vary. Polymaster takes no responsibility for the quality of water held in a tank. \*Free delivery only applies to some regions and tank sizes.

# Slendastyle™ Tanks

THE SLENDASTYLE™ RANGE PROVIDES SLIM-PROFILE WATER STORAGE OPTIONS UP TO 5000L.



## CERTIFIED

- Space saving modern design ideal for tight spaces
- Hand grips for easy lifting
- Can be coupled to other tanks for even greater volume
- 22 Colorbond® colours to match your home!



Pages 18-19  
**COLOUR RANGE**

Pages 82-83  
**DELIVERY & INSTALLATION**

**ONLINE WATER CALCULATOR**

CALCULATOR.  
POLYMASTER.COM.AU



**WHY CHOOSE POLYMASTER?**  
SEE PG.4

## PUMP OPTIONS

\* 2 years warranty on pumps

### 1 SUBMERSIBLE PUMP SYSTEM

- High volume/pressure stainless steel submersible pump suitable for single-storey and double-storey dwellings
- Automatic switching device fitted for rain to mains automatic changeover with no water supply interruption



### 2 PACKAGED PUMP UNIT

- Sits neatly beside any size tank and includes a pump, protected in a poly pump house - for house amenities supply



### 3 40LPM GARDEN PUMP SYSTEMS

- Constant pressure controller for ease of watering & garden supply



The Slendastyle™ rainwater tanks have been designed to hold the maximum volume of water for the minimum surface area used.

## SLENDASTYLE TANKS

CODE	LITRES	DIMENSIONS (mm)	OVERFLOW POSITION	OUTLET POSITION	SIEVE POSITION
SLST600	600 (130 gal)	1220L x 580W x 1265H	12:00 Std /6:00 Alt	6:00 Std /12:00 Alt	6:00 Std /12:00 Alt
SLST1050	1050 (230 gal)	1460L x 690W x 1515H	12:00 Std /6:00 Alt	6:00 Std /12:00 Alt	6:00 Std /12:00 Alt
SLST2000	2000 (440 gal)	2370L x 600W x 2010H	12:00 Std /6:00 Alt	6:00 Std /12:00 Alt	6:00 Std /12:00 Alt
SLST3000	3000 (660 gal)	2570L x 790W x 2050H	12:00 Std /6:00 Alt	6:00 Std /12:00 Alt	6:00 Std /12:00 Alt
SLST5000	5000 (1100 gal)	3290L x 1020W x 2010H	12:00 Std /6:00 Alt	6:00 Std /12:00 Alt	6:00 Std /12:00 Alt

### WITH OPTION 1 - SUBMERSIBLE PUMP

CODE	DESCRIPTION
SLST1050AP	1050 ltr Tank + Submersible Pump
SLST2000AP	2000 ltr Tank + Submersible Pump
SLST3000AP	3000 ltr Tank + Submersible Pump
SLST5000AP	5000 ltr Tank + Submersible Pump

### WITH OPTION 3 - GARDEN PUMP

CODE	DESCRIPTION
SLST1050GPS	1050 ltr Tank + Garden Pump
SLST2000GPS	2000 ltr Tank + Garden Pump
SLST3000GPS	3000 ltr Tank + Garden Pump
SLST5000GPS	5000 ltr Tank + Garden Pump

Please specify which pump system you require at time of order.

## AVAILABLE IN WATERGUARD

- New technology to keep your water fresher for longer.

CODES: WG2000 / WG3000 / WG5000

\* Refer to the SLST codes above for tank dimensions



- See pg.11 for Waterguard info.

## SLENDASTYLE TANK STANDARD FITTINGS

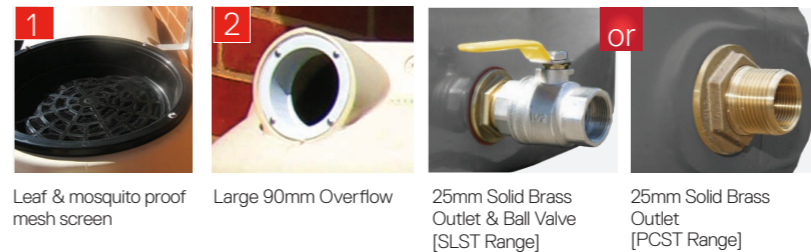

All measurements are approximate due to variable shrinkage during manufacture. Due to pigment variations with raw material manufacturers, colour shades may vary. Polymaster takes no responsibility for the quality of water held in a tank. \*Free delivery only applies to some regions and tank sizes.

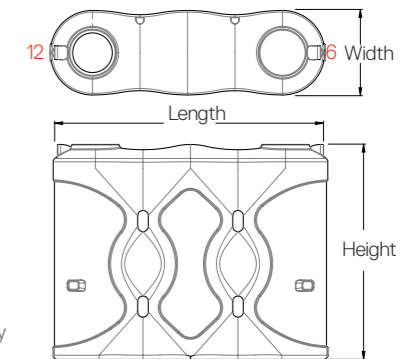

## POLYCHOICE

### COST-EFFECTIVE SOLUTION

- Modern slim design perfect for small urban spaces
- Australian Standards AS4766:2006
- Available in 12 standard colours
- 7 years warranty for your peace of mind
- 2000L tank fits through a standard doorway

\*5% surcharge on the optional colour range



# 2020L Slimline Tank

ACHIEVE A 6 STAR ENERGY RATING WITH OUR 2020L TANK & PUMP COMBINATION ON NEW HOME BUILDS



\* Tank Only \* 2 years warranty on pump

Pages 18-19  
**COLOUR RANGE**

Pages 82-83  
**DELIVERY & INSTALLATION**

**ONLINE WATER CALCULATOR**  
CALCULATOR.POLYMASTER.COM.AU

**WHY CHOOSE POLYMASTER?**  
SEE PG.4

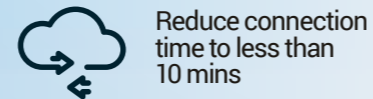
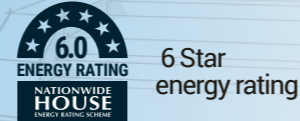

Connects directly to house

**Install faster with our NEW 2020 tank with built-in pump to reduce connection time to less than 10 mins**

- Quick To Install
- Built-in Pump
- Save On Connection
- Reliable
- Built Tuff
- Fits through tight doorways

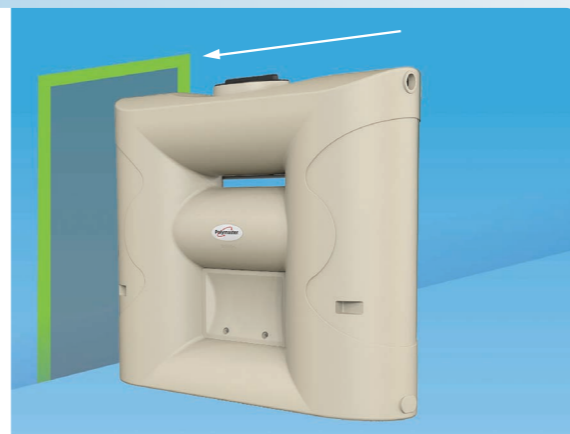

## TANK & PUMP COMBINATION

CODE	TANK DESCRIPTION	DIMENSIONS	PUMP WITH RAIN/MAINS CHANGEOVER DEVICE
BSLT2020H4	2020L Tank & Pump	735W X 2105L X 2010H	Hyjet 370 watt pump for single storey dwellings
BSLT2020H5	2020L Tank & Pump	735W X 2105L X 2010H	Hyjet 550 watt pump for multi storey dwellings

## AVAILABLE IN WATERGUARD

- New technology to keep your water fresher for longer.

CODES: WG2020H4, WG2020H5

\* Refer to the BSLT codes above for tank dimensions



- See pg.11 for Waterguard info.

## COLOUR RANGE



\* Optional colours available on 5% surcharge

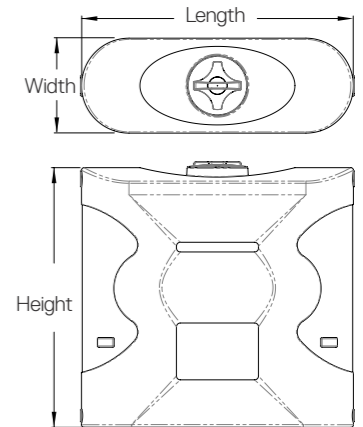

## 2020L SLIMLINE TANK SHOWING STANDARD FITTINGS

1. Leaf & mosquito proof mesh screen
2. 2 x Large 90mm overflows (1 each end) + 1 cap
3. 2 x 25mm outlets (1 each end) + 1 plug
4. Door to conceal pump
5. Pump installed with rain/ mains changeover (sits behind door)
6. Flexible hoses for quick connection



→ Overflows & outlets are fitted on both ends to suit any set up